

Slotted UpBright®



ASSEMBLY INSTRUCTIONS

Product:

**Slotted UpBright® Illuminated Retail
Display System 610mm**

ASSEMBLY INSTRUCTIONS

Product: Slotted UpBright® Illuminated Retail Display System 610mm

Manufacturer: Big Instore

Slotted UpBright®

IMPORTANT: INDOOR USE ONLY

This display system is designed and rated for internal retail environments only. Do not install outdoors or in areas subject to damp, rain, or direct moisture.

CRITICAL: WALL SUITABILITY CHECK

STOP AND READ BEFORE DRILLING

1. Load Bearing:

Ensure your wall is capable of supporting the combined weight of the frame 7.5KG's **plus** your intended merchandise load.

2. Wall Flatness & Size:

Ensure your installation wall is **completely flat**. Installing this frame on a bowed or uneven wall will distort the aluminium profiles, making the graphic difficult to fit. Ensure the clear wall area matches or exceeds the frame size (610mm x 2400mm).

3. Plasterboard/Drywall Disclaimer:

The fixing holes in the Slotted UpBright® frame are pre-drilled at specific structural intervals.

These positions may not align with the stud work in your wall.

- **Minimum Thickness:** If fixing to plasterboard, it must be a minimum of **12.5mm thick** (Standard Board).
Do not install on lightweight 9.5mm board.
- **Condition:** Ensure the board is dry and firmly screwed to the studs.
- **Liability:** Big Instore accepts no liability for installation failure caused by weak, damp, or unsuitable wall substrates.

Supplied Fixing Kit

- **Wall Plugs:** Fischer DuoPower 6 | **Qty 30** (Suitable for Solid & Hollow walls)
- **Screws:** 5mm x 40mm Pan Head/Round Head | **Qty 30**
Note: Do not use countersunk screws from your own kit, as they will not seat correctly
- **Cable Management:** Self Adhesive Cable Clips

Tools Required

- Spirit Level (Long)
- Pencil & Tape Measure
- Power Drill
- 6mm Drill Bit (Suitable for your wall type)
- Hammer (for wall plugs)
- Screwdriver/ Impact Driver (Pozi or Torx bit to match supplied screws)
- Clean, dry cloth

ASSEMBLY INSTRUCTIONS

Product: Slotted UpBright® Illuminated Retail Display System 610mm

Manufacturer: Big Instore

Slotted UpBright®

Stage 1: Base Installation (The Anchor)

The goal is to fix the Bottom Bar perfectly level. This will act as your reference point for the rest of the build.

1. **Position:** Place the Bottom Bar extrusion against the wall at your desired install height. Use a spirit level to ensure it is **perfectly horizontal**.
2. **Mark:** Holding the bar firm, circle the pre-drilled fixing holes with your pencil.
3. **Drill:** Remove the bar. Drill the marked holes using a **6mm drill bit** (min. 45mm depth). Insert the **Fischer DuoPower** plugs.
4. **Fix:** Align the bar with the plugs and screw it to the wall using the **5×40mm screws**.
 - **Check:** Verify it is level one last time. This is the foundation for your display.



ASSEMBLY INSTRUCTIONS

Product: Slotted UpBright® Illuminated Retail Display System 610mm

Manufacturer: Big Instore

Slotted UpBright®

Stage 2: Building the Frame

Since this system does not use internal joiner bars or corner keys, you will build the frame piece-by-piece directly on the wall. Accurate alignment of the joins is critical.

1. Lower Uprights:

- Position the **Lower Left** and **Lower Right** uprights against the wall.
- Ensure they butt up tightly against the ends of the **Bottom Bar** (installed in Stage 1) to form a neat corner.
- Use a spirit level to ensure they are **perfectly vertical (plumb)**.
- Mark the holes.



ASSEMBLY INSTRUCTIONS

Product: Slotted UpBright® Illuminated Retail Display System 610mm

Manufacturer: Big Instore

Slotted UpBright®

Marking & Measuring (The Fail-Safe):

- Circle the fixing holes with your pencil.
- **CRITICAL:** Draw a pencil line up the **inside edge** of both uprights on the wall.
- Remove the uprights and measure the distance between the two pencil lines.
- **Check:** The distance should match the internal width of your bottom bar (approx. 530mm for the 610mm wide unit). If the measurement is incorrect, adjust your marks before drilling.

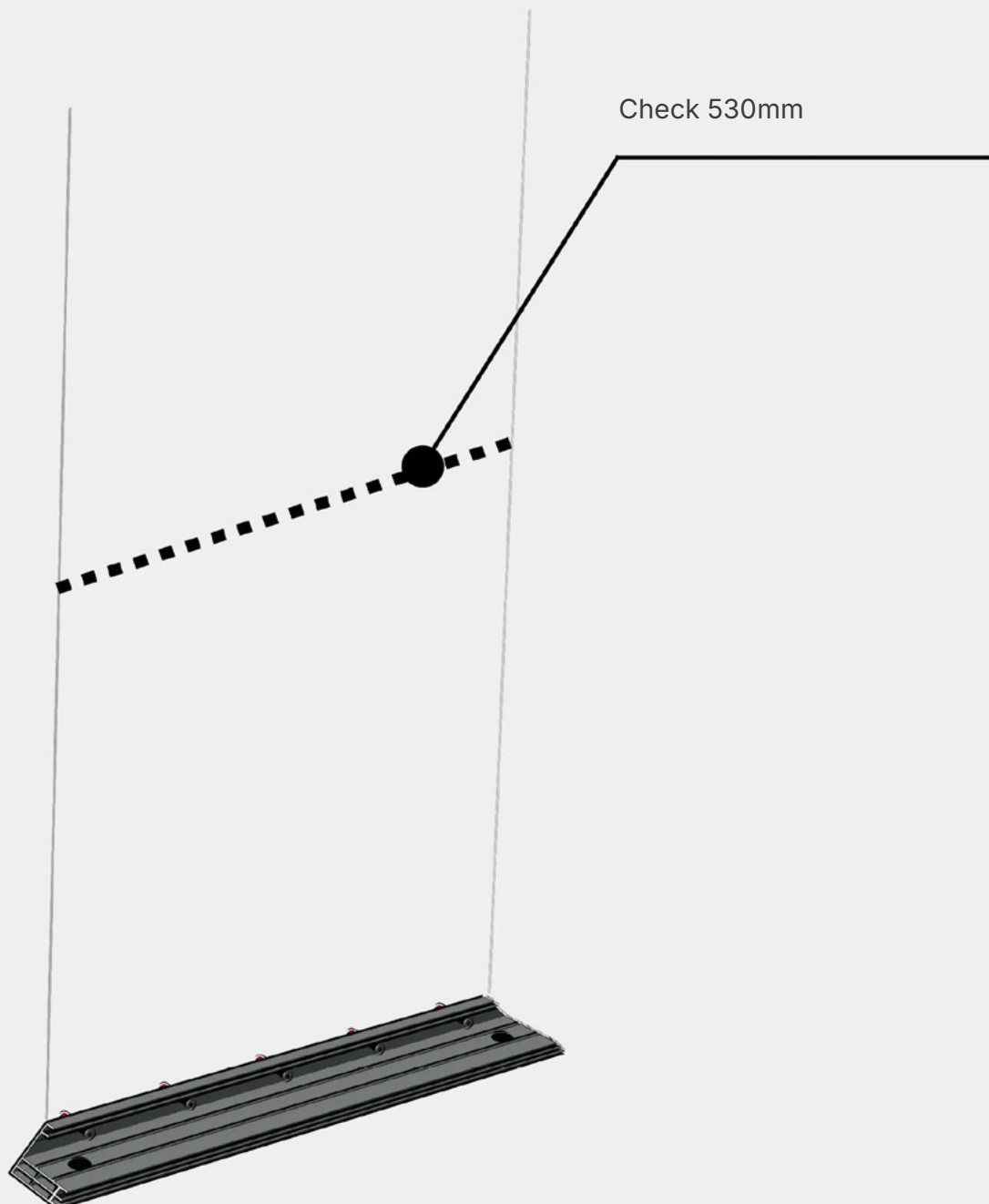

ASSEMBLY INSTRUCTIONS

Product: Slotted UpBright® Illuminated Retail Display System 610mm

Manufacturer: Big Instore

Slotted UpBright®

Drill & Fix: Drill the holes, insert plugs, replace the uprights, and screw them to the wall.



ASSEMBLY INSTRUCTIONS

Product: Slotted UpBright® Illuminated Retail Display System 610mm

Manufacturer: Big Instore

Slotted UpBright®

- **Top Uprights:**

- Place the **Top Left** and **Top Right** uprights directly on top of the installed lower sections.
- **CRITICAL:** Ensure the cut ends meet flush and the internal groove (for the graphic) aligns perfectly.

- **Marking & Measuring (Top Section):**

- Circle the fixing holes with your pencil.
- **Check:** Draw a pencil line up the **inside edge** of both top uprights.

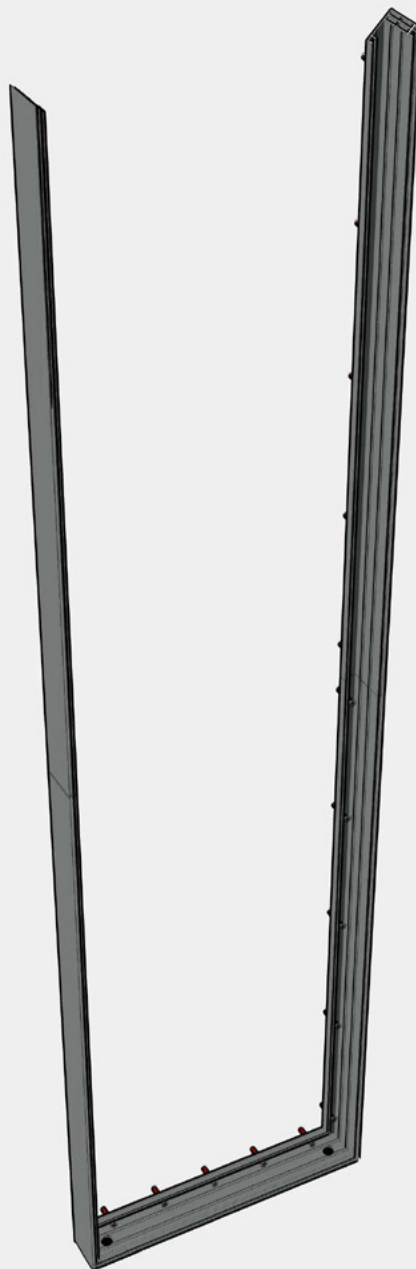

ASSEMBLY INSTRUCTIONS

Product: Slotted UpBright® Illuminated Retail Display System 610mm

Manufacturer: Big Instore

Slotted UpBright®

- Remove the uprights and measure the distance between these new lines. **They must match the measurement of the lower section exactly.**

Tip: If the measurement is different, your wall may be bowing out. Adjust your position slightly to ensure the frame remains square.

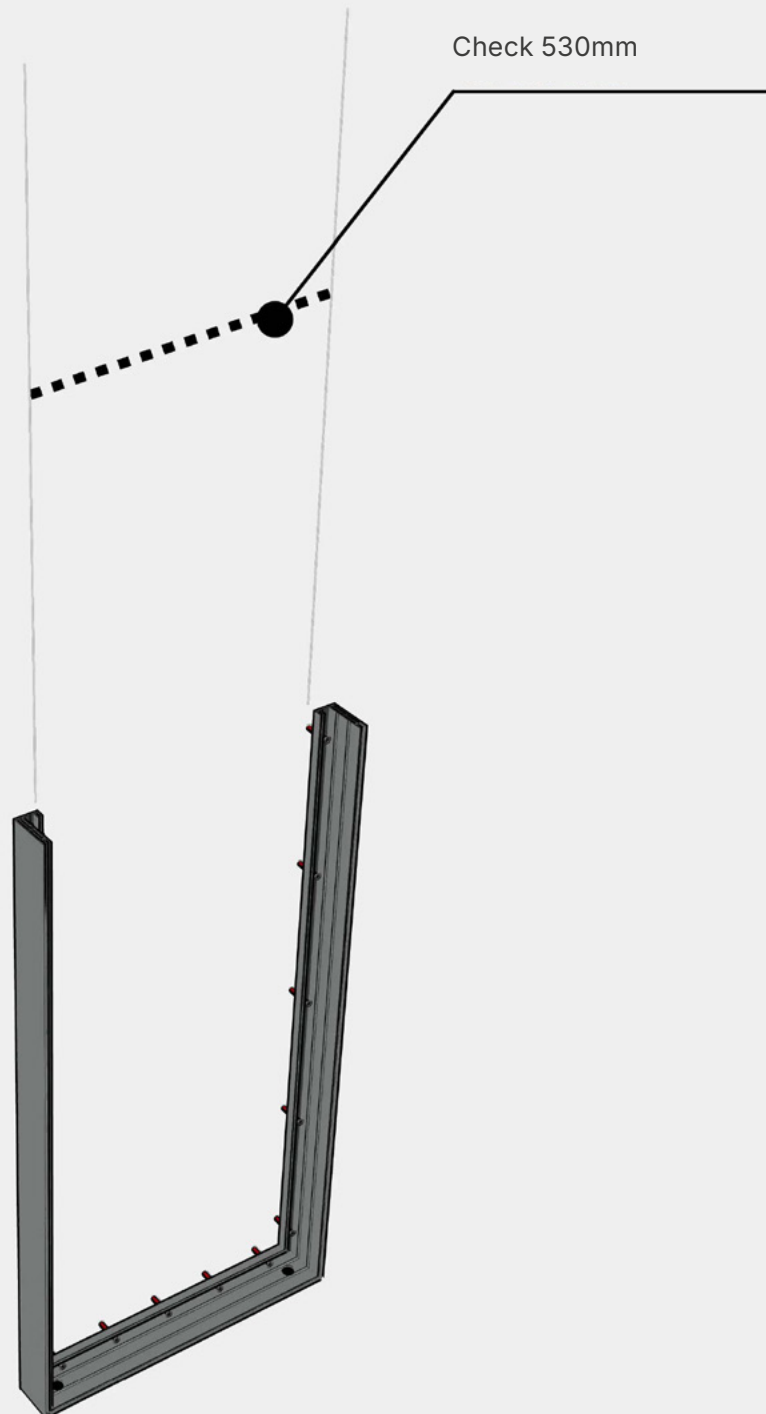

ASSEMBLY INSTRUCTIONS

Product: Slotted UpBright® Illuminated Retail Display System 610mm

Manufacturer: Big Instore

Slotted UpBright®

Drill & Fix: Drill the holes, insert plugs, replace the uprights, and screw them to the wall.

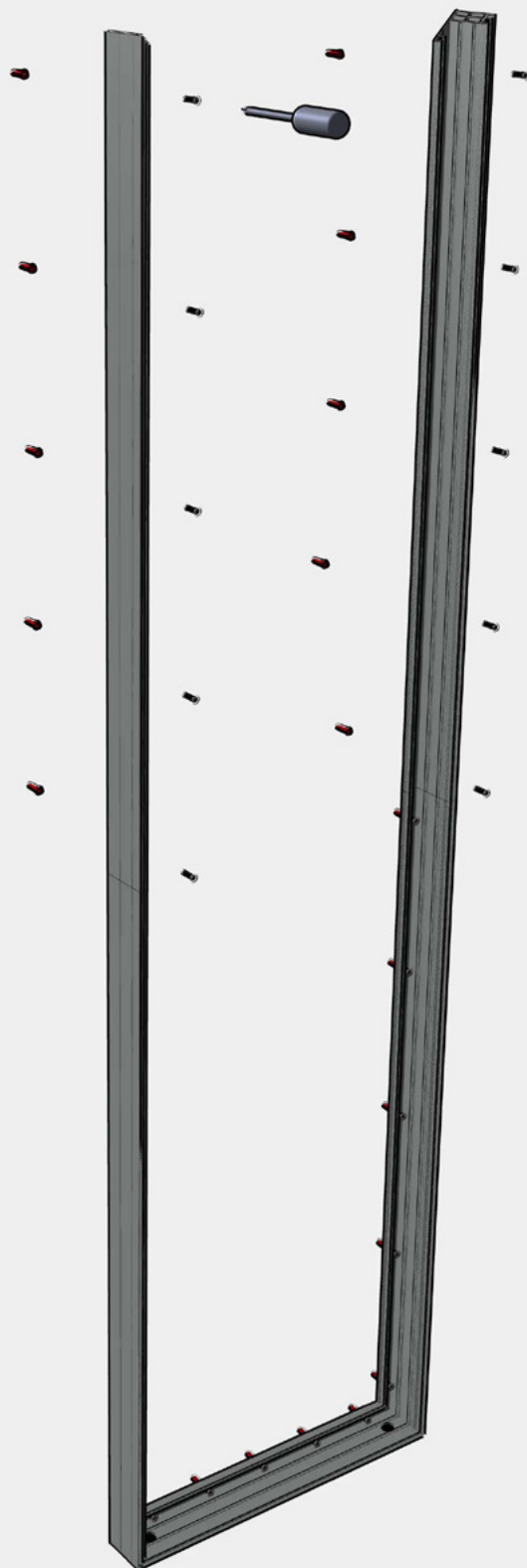

ASSEMBLY INSTRUCTIONS

Product: Slotted UpBright® Illuminated Retail Display System 610mm

Manufacturer: Big Instore

Slotted UpBright®

Top Bar Positioning & Marking:

- Place the **Top Bar** extrusion across the top of the uprights to complete the rectangle.
- Ensure the corners are tight and square against the uprights.
- Circle the fixing holes with your pencil.

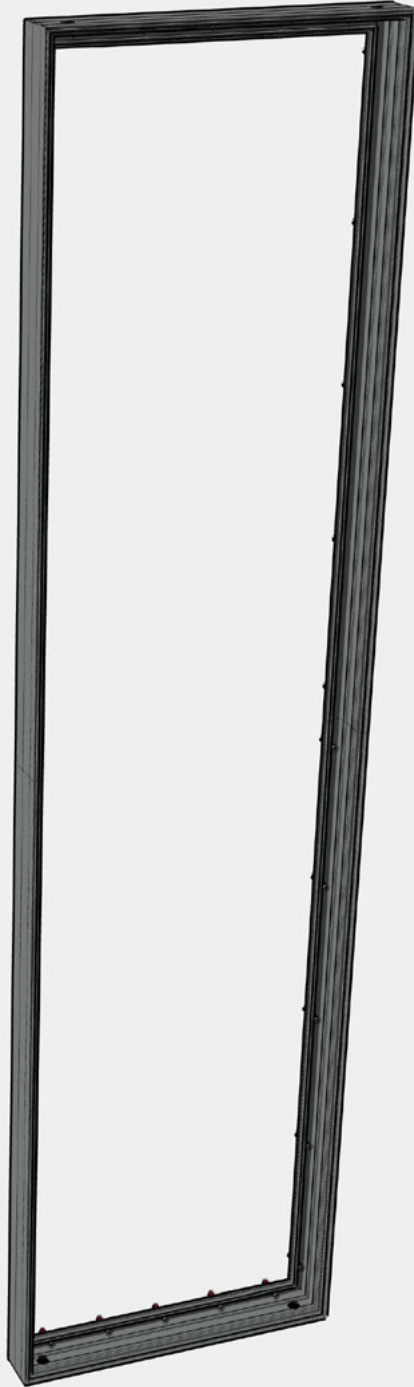

ASSEMBLY INSTRUCTIONS

Product: Slotted UpBright® Illuminated Retail Display System 610mm

Manufacturer: Big Instore

Slotted UpBright®

Top Bar Fixing:

- Remove the bar. Drill the holes and insert Plugs.
- Place the bar back into position and screw it to the wall.

Final Check: Run Your finger across the joins. They should be smooth to prevent snagging the fabric graphic later.

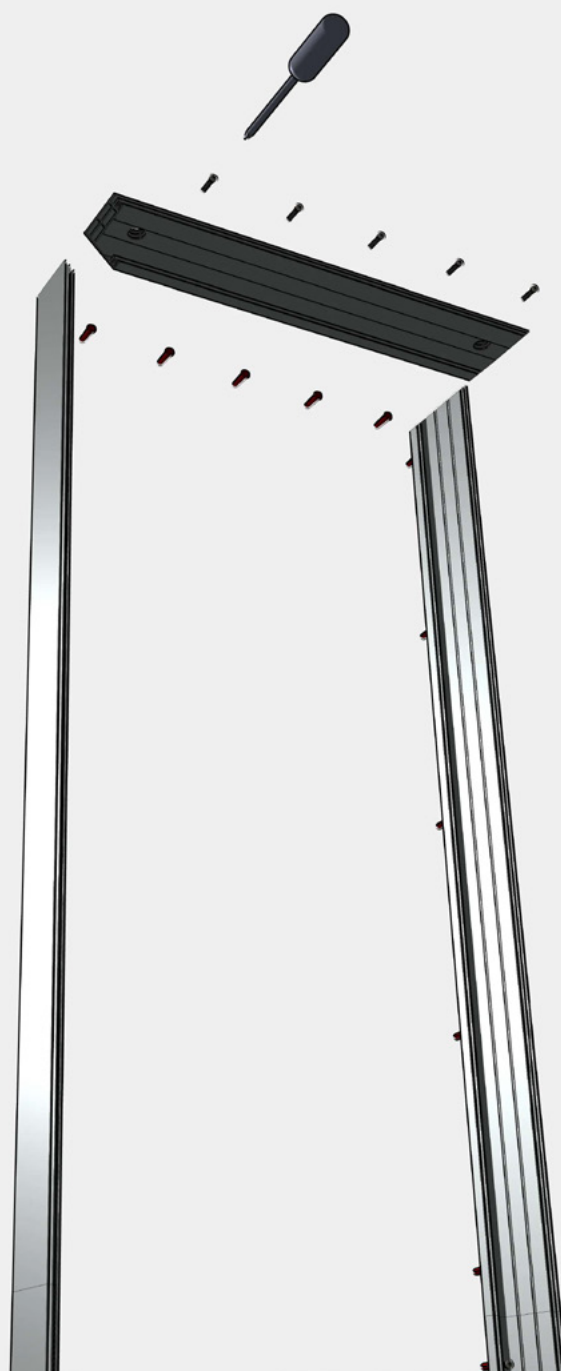

ASSEMBLY INSTRUCTIONS

Product: Slotted UpBright® Illuminated Retail Display System 610mm

Manufacturer: Big Instore

Slotted UpBright®

Stage 3: Reflector Installation

The reflector bounces light forward to illuminate your graphic evenly. It must be installed before the lighting.

1. **Identify:** Locate the plain white fabric sheet (Reflector).
2. **Orientation:** Ensure the **White Side** is facing you (facing forward into the room). The unfinished/grey side should face the wall.
3. **Install:** Press the silicone edge (SEG) into the **rear groove** of the frame (the groove closest to the wall). You'll see a QR Code on the fabric bag that will take you through to a video instruction of how to do this
 - Start at the four corners.
 - Work your way into the centre of each side.



ASSEMBLY INSTRUCTIONS

Product: Slotted UpBright® Illuminated Retail Display System 610mm

Manufacturer: Big Instore

Slotted UpBright®

Stage 4: Lighting Installation

You will be installing 4 separate LED strips in total (2 on the left upright, 2 on the right).

1. **CRITICAL CHECK: Check Your Labels**

- If you are installing multiple displays of different sizes (e.g., some 610mm and some 1005mm), check the box label on the LED packaging.
- Ensure the LED kit matches the frame size you are building. Installing the wrong LEDs will result in **incorrect light distribution and uneven illumination**.

2. Preparation: Ensure the inside of the aluminium uprights is free of dust and grease.

3. Cable Routing: Decide where your power source is (Left or Right).

On that side, identify the pre-installed **Heyco Bushing (Grommet)** at the top or bottom of the frame.

4. First Side Installation:

- **Lower Strip:** Take one LED strip. Connect it to the cable at the bottom (or position it so the connector is at the centre split). Peel the liner and press firmly into the **Lower Upright ribs**.
- **Upper Strip:** Take the second LED strip. Peel and press firmly into the **Top Upright ribs**.



ASSEMBLY INSTRUCTIONS

Product: Slotted UpBright® Illuminated Retail Display System 610mm

Manufacturer: Big Instore

Slotted UpBright®

1. **Connect:** Join the two strips together at the centre of the upright (where the frames join) using the **white Molex connectors**. Tuck the excess wire into the wall cavity behind the frame.

2. **Repeat the process** for the opposite upright.

- Install the Lower Strip and Upper Strip.
- Connect the Molex plugs in the centre.

Adhesion Warning:

- **Stop:** Run your thumb firmly down the entire length of all 4 LED strips.
- The tape must have **100% contact** with the metal to dissipate heat. Gaps or air bubbles will cause the LEDs to fail prematurely.

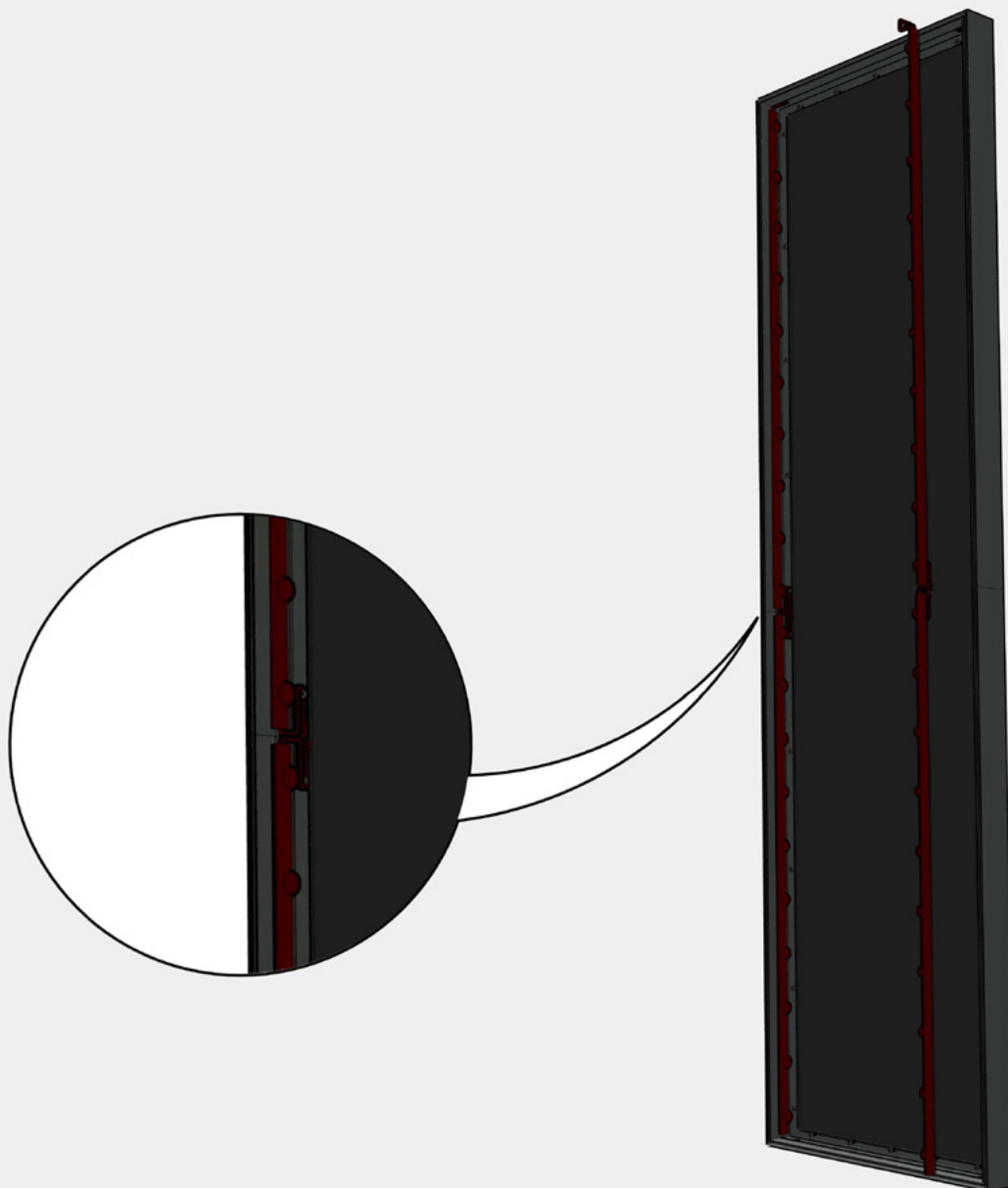

ASSEMBLY INSTRUCTIONS

Product: Slotted UpBright® Illuminated Retail Display System 610mm

Manufacturer: Big Instore

Slotted UpBright®

Cable Exit (Power Routing):

- Now that the LEDs are securely adhered, feed the input power cable (Molex end) through the pre- installed **Heyco Bushing (Grommet)**.
- **Top Power:** If your power supply is located above the frame, feed the cable through the **Top Grommet**.
- **Bottom Power:** If your power supply is located below the frame, feed the cable through the **Bottom Grommet**.

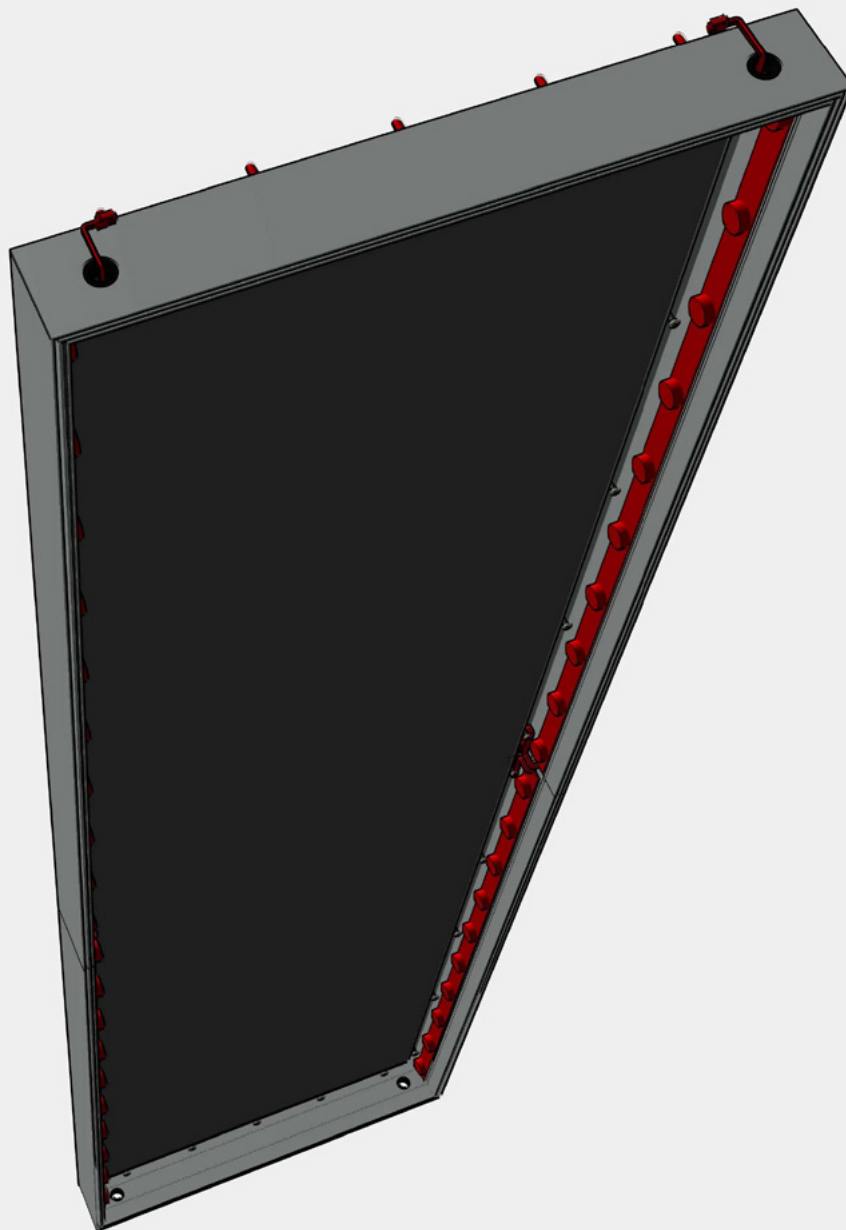

ASSEMBLY INSTRUCTIONS

Product: Slotted UpBright® Illuminated Retail Display System 610mm

Manufacturer: Big Instore

Slotted UpBright®

Stage 5: Power Connection

1. **External Cabling:** Connect the provided cable assembly to the Molex connectors sticking out of the grommets.
2. **Cable Management:** Use the provided self-adhesive cable clips to route the loose wire neatly along the top or bottom of the frame toward the power supply.

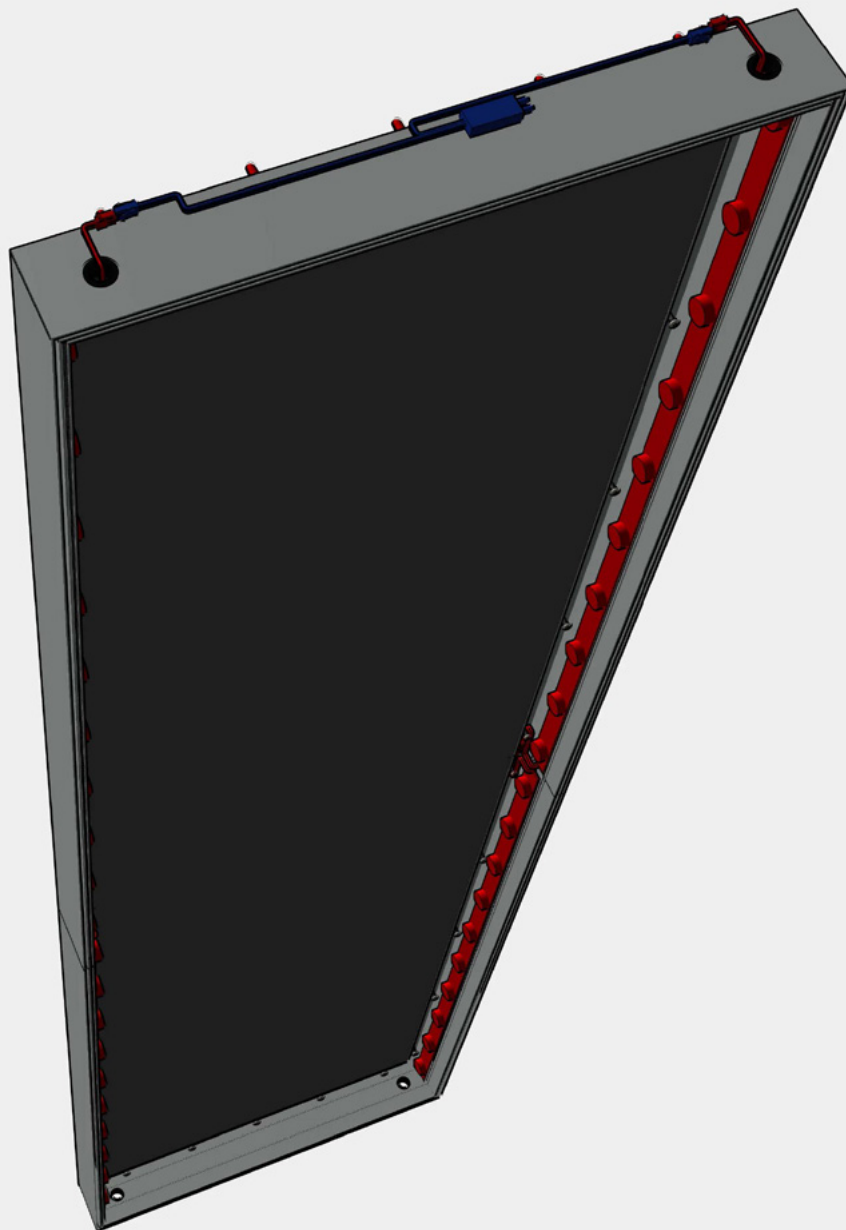

ASSEMBLY INSTRUCTIONS

Product: Slotted UpBright® Illuminated Retail Display System 610mm

Manufacturer: Big Instore

Slotted UpBright®

1. **Driver Connection:** Plug the cable assembly into the Wireland Connector on the external Power Supply Unit (PSU).
2. **PSU Placement:** Position the PSU in a clean, open space (e.g., on the floor or mounted to a skirting board). Ensure it is not covered by boxes or merchandise.
3. **Power On:** Plug the standard mains plug into your wall socket.
 - **WARNING:** If using an extension lead, ensure it is not overloaded by other high-power devices.

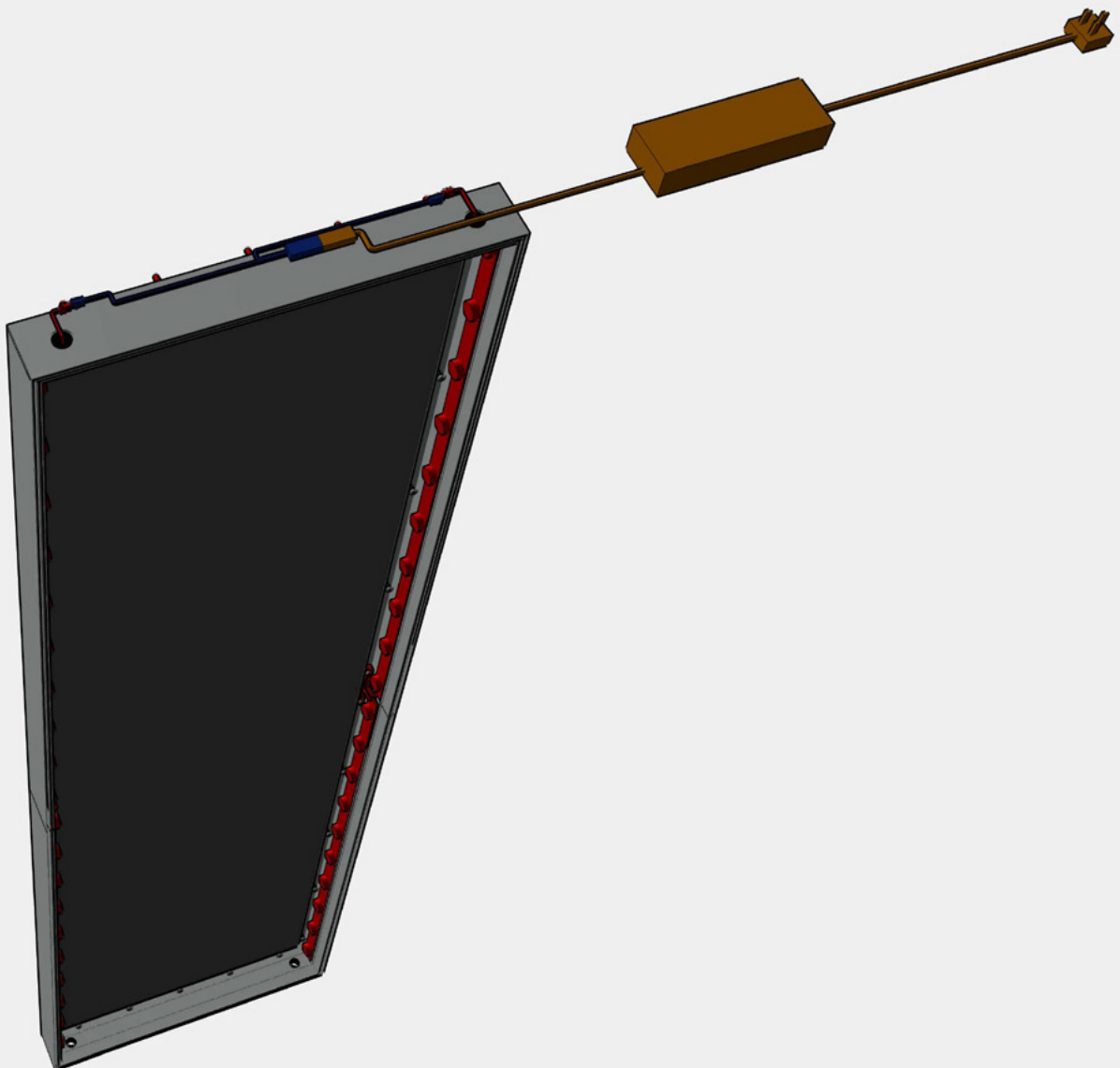

ASSEMBLY INSTRUCTIONS

Product: Slotted UpBright® Illuminated Retail Display System 610mm

Manufacturer: Big Instore

Slotted UpBright®

Stage 6: Completion

1. **Main Graphic:** Install your printed SEG graphic into the front Inner groove of the frame. Ensure the fabric is taut and wrinkle-free.
2. **Merchandising:** Insert your shelf brackets or accessories into the vertical slots.
3. **Final Check:** Switch on the power to verify all LEDs are illuminated and the graphic is evenly lit.

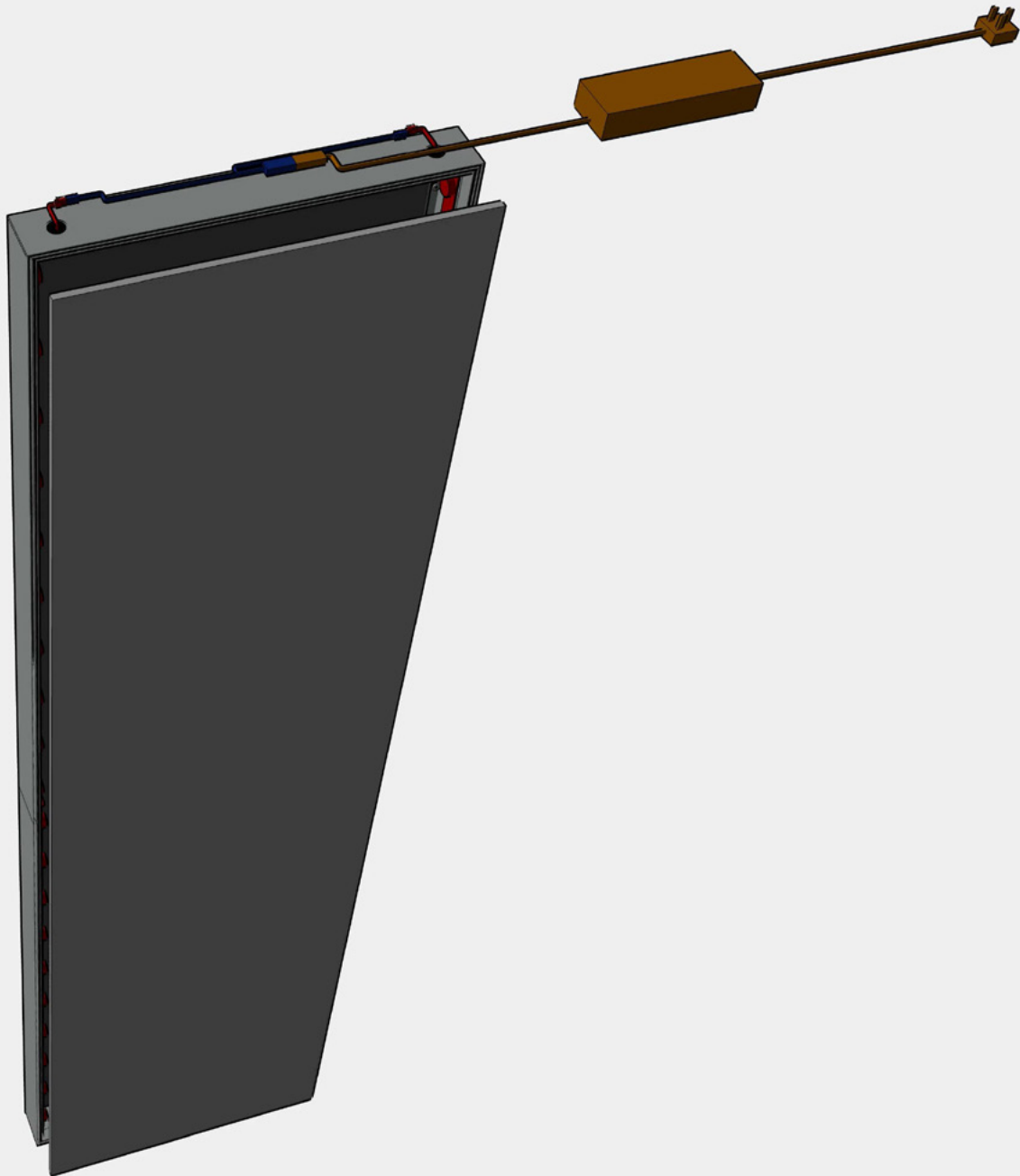

Slotted UpBright[®]

We didn't just raise the bar. We lit it up.[™]

www.slottedupbright.com